



Flat Scroll Column And Corner Scroll Column



Assembly and Installation Instructions

**Flat Scroll
Column**





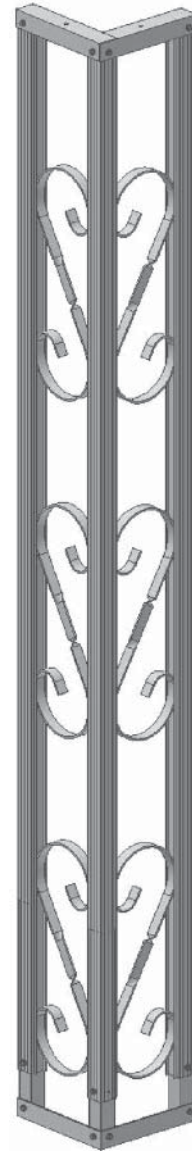

**Corner Scroll
Column**



Check the material received!
Match your shipment with the Bill of Materials.
If there is a shortage or wrong material,
call Dealer Service immediately.

Safety is important!
Wear Safety Glasses and Work Gloves.
Follow all safety practices while assembling
and installing this product.

DURA-BILT Products, Inc. P.O. Box 188 Wellsburg, N.Y. 14894
Dealer Service 570-596-2000

Fasteners	Description
	#8 x 1/2" Self Drilling Screw
	#12 x 3/4" Self Drilling Screw
	#12 x 1" Self Drilling Screw
	Expansion Bolt (Concrete Anchor)
	#14-10 x 2-1/2" Galvanized Hex Washer Head Screw Attaches Anchor to Wooden Deck. <u>(Full Embedment Required!!!)</u>

Note: For wood application the Flat Scroll and Corner Columns will require the installer to drill one (1) more 5/16" hole on the Header side to allow for the installation of two (2) #14-10 x 2-1/2" fasteners in the Adjustable Insert.

Note: If you are installing Columns on a Pressure Treated Lumber Deck. With your order you will receive a 4" x 8-1/2" piece of Black Flashing with paper coated adhesive on one side for each Column. Peel the paper off from the Flashing and stick the flashing to the bottom of the Column. Then trim the excess Flashing from around the bottom of the Column.

Tools Required

Drill Tape Measure Metal Saw

Level Chalk Line Clamps

Hammer Screw Gun

Nut Driver Bits with Magnetic Head: 1/4", 5/16" & 3/8"

7/16" Deep Socket or Nut Driver (For Concrete Anchor)

Drill Bits: 1/4" - 1/2" Masonry

Flat Scroll Column

“L” measurement adjustable to level the Awning or Roof

When Scroll Columns are ordered with Aluminum Awning or Dura-Lock Roof, follow these instructions in conjunction with the Awning or Roof assembly instructions.

Install Columns into Front Header

Assemble sections of Deluxe Front Header together as described in the Instructions. Space Columns as shown on Column Spacing Charts. Install into the Front Header on the ground. The Column is located against the back leg of the Front Header with the Spacer toward the front. Put one #12 x 1” screw through the front leg of the Front Header and through the center of the Spacer. Erect the Columns and Front Header to desired location in front of the home.

Adjust for Height

Pull Columns upward to adjust the Deluxe Header Height. Clamp Adjustable Insert at desired height. Illustration in Awning/Roof Instructions shows clamping. Continue assembly as described in your Awning/Roof Instructions.

Attach Adjustable Insert

Note: You must use a 1/8” drill and pre-drill the holes in the wood deck for the fastener. Fasten Adjustable Insert to wood with two (2) #14-10 x 2-1/2” Galvanized Hex Washer Head Screws. **(Full Embedment Required!!!)**

For Concrete, mark the location of the Expansion Bolt, then move the column and use a 1/2” masonry bit to drill the hole for the Expansion Bolt. Seat the Expansion Bolt, then move the Column over Bolt and secure Adjustable Insert to the Bolt. Level Awning/Roof as described in Awning or Roof Instructions.

Secure Inserts to Columns

Use #12 x 3/4” screws provided to secure insert to Column Uprights. Install in holes provided. One screw per Column Upright.

Note: For Columns with extra long Inserts, an extra “S” Scroll is supplied. If application indicates, center “S” Scroll between Column Base and Bottom Scroll of Column. Fasten with #8 x 1/2” Screw in four places.

Put one #12 x 1” screw through the front leg of the Deluxe Front Header And through the center of the Flat Column Spacer.

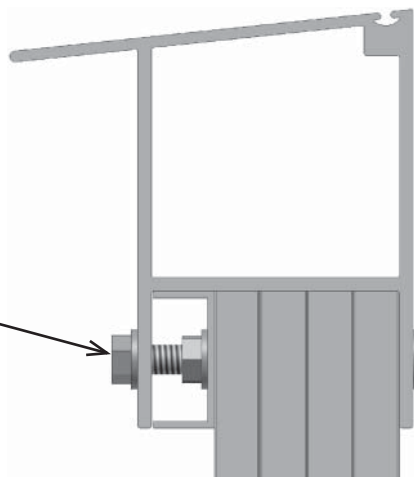

Fasten Columns to Front Header
Fasten Column to Deluxe Front Header using #12 x 3/4” screws provided. One screw through back leg of Front Header and into each Column Upright.

Corner Scroll Column

“L” measurement adjustable to level the Awning or Roof

The Corner Columns are shipped with four #12 X 3/4” screws that are installed at top so that Column can be shipped fully assembled. Two of these screws must be removed from the side of the column that will be positioned flush against the front wall of the Deluxe Header.

Notch must be cut in back leg of Deluxe Header for each Corner Column. See drawing below. Notch is 1-1/2” wide and 1” deep. This will allow the Corner Column to slide up into the Header. To mark Notch cut, place the Column in its proper position and plumb.

After cutting Notch(es) install Corner Column in Front Header and Fasten into position with two #12 X 1” screws that replace the two #12 x 3/4” screws that were taken out. These two screws will secure Column top to Deluxe Front Header. See Drawing.

Pull Columns upward to adjust for Deluxe Header Height. Clamp insert at desired height. Illustration in Awning or Roof Instructions show clamping application. Continue Awning or Roof assembly per the instructions.

Note: You must use a 1/8” drill and pre-drill the holes in the wood deck for the fastener. Fasten Adjustable Insert to wood with two (2) #14-10 x 2-1/2” Galvanized Hex Washer Head Screws. (Full Embedment Required!!!)

For Concrete, mark the location of the Expansion Bolt, then move the column and use a 1/2” masonry bit to drill the hole for the Expansion Bolt. Seat the Expansion Bolt, then move the Column over Bolt and secure Adjustable Insert to the Bolt. Level Awning/Roof as described in Awning or Roof Instructions.

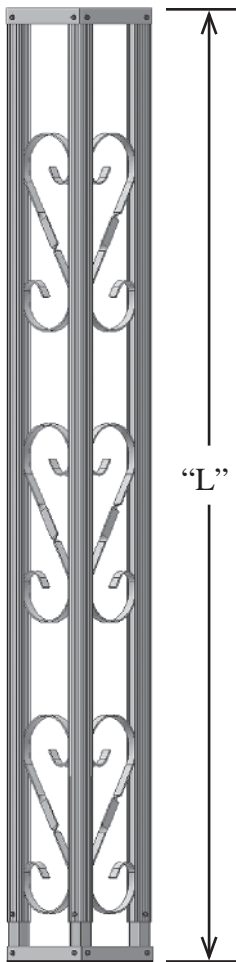

Black
Flashing

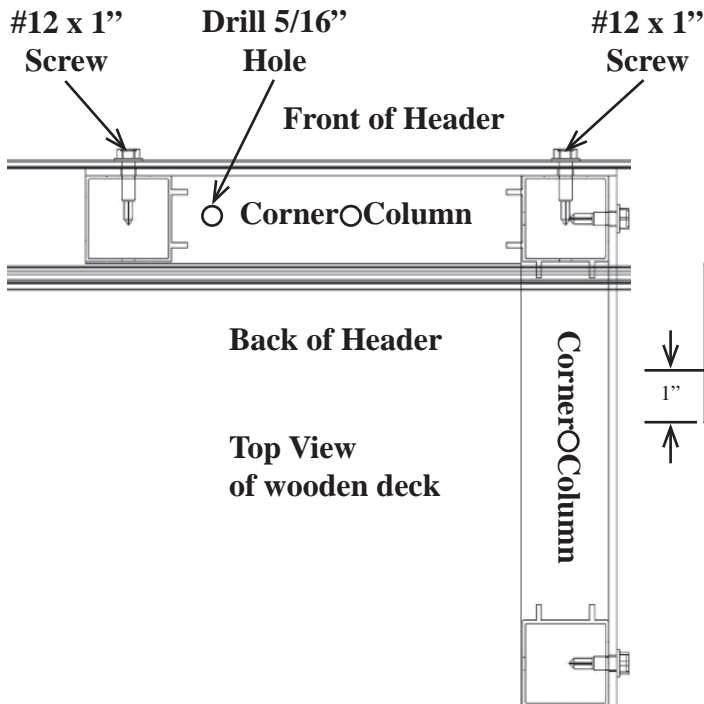

Use #12 X 3/4” screws provided to secure Insert to Column Uprights. Install in holes provided. Use one screw per Upright.

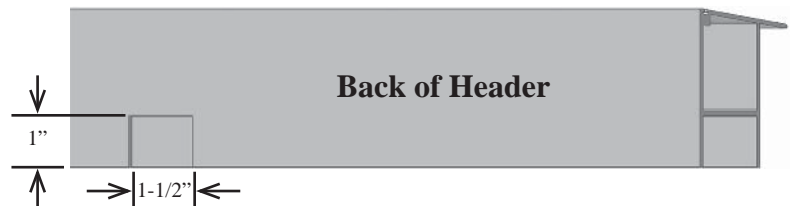

For Columns with extra long Inserts, two extra “S” Scrolls are supplied. If application indicates, center “S” Scroll between Column Base and Bottom Scroll of Column. Fasten each Scroll with #8 X 1/2” Screw in four places.